

Photometrics®  
*CoolSNAP*

**USER MANUAL** CoolSNAP<sub>cf</sub> and CoolSNAP<sub>ES</sub>





---

**User Manual for CoolSNAP<sub>cf</sub> and CoolSNAP<sub>ES</sub> Systems**

---

© Copyright 2005

Roper Scientific, Inc.  
3440 East Britannia Drive  
Tucson, Arizona 85706  
Tel: 800.874.9789/520.889.9933  
Fax: 520.295.0299

All rights reserved. No part of this publication may be reproduced by any means without the written permission of Roper Scientific, Inc.

Printed in the United States of America.

CoolSNAP is a trademark of Roper Scientific, Inc.

Photometrics, PVCAM, and Roper Scientific are registered trademarks of Roper Scientific, Inc.

Acrobat and Reader are registered trademarks of Adobe Systems Incorporated in the United States and/or other countries.

Mac, Macintosh, and Panther are trademarks of Apple Computer, Inc., registered in the U.S. and other countries.

Pentium is a registered trademark of Intel Corporation. Xeon is a trademark of Intel Corporation.

Windows is a registered trademark of Microsoft Corporation.

Other brand and product names are the trademarks or registered trademarks of their respective owners and manufacturers.

The information in this publication is believed to be accurate as of the publication release date. However, Roper Scientific does not assume any responsibility for any consequences including any damages resulting from the use thereof. The information contained herein is subject to change without notice. Revision of this publication may be issued to incorporate such change.

57-061-001 Rev G0



## LIMITED WARRANTY — Photometrics Analytical Instrumentation

Photometrics, a division of Roper Scientific, Inc. (“Photometrics,” us,” “we,” “our”) makes the following limited warranties. These limited warranties extend to the original purchaser (“You”, “you”, “Your”, “your”) only and no other purchaser or transferee. We have complete control over all warranties and may alter or terminate any or all warranties at any time we deem necessary.

### Basic Limited One (1) Year Warranty

Photometrics warrants this product against substantial defects in materials and/or workmanship for a period of up to one (1) year after shipment. During this period, Photometrics will repair the product or, at its sole option, repair or replace any defective part without charge to you. You must deliver the entire product to the Photometrics factory or, at our option, to a factory-authorized service center. You are responsible for the shipping costs to return the product. International customers should contact their local Photometrics authorized representative/distributor for repair information and assistance, or visit our technical support page at [www.photomet.com](http://www.photomet.com).

### Limited One (1) Year Warranty on Refurbished or Discontinued Products

Photometrics warrants, with the exception of the CCD imaging device (which carries NO WARRANTIES EXPRESS OR IMPLIED), this product against defects in materials or workmanship for a period of up to one (1) year after shipment. During this period, Photometrics will repair or replace, at its sole option, any defective parts, without charge to you. You must deliver the entire product to the Photometrics factory or, at our option, a factory-authorized service center. You are responsible for the shipping costs to return the product to Photometrics. International customers should contact their local Photometrics representative/distributor for repair information and assistance or visit our technical support page at [www.photomet.com](http://www.photomet.com).

### Normal Wear Item Disclaimer

Photometrics does not warrant certain items against defect due to normal wear and tear. These items include internal and external shutters, cables, and connectors. *These items carry no warranty, expressed or implied.*

### Shutter Warranty

Photometrics warrants the standard, factory-installed shutter of all our products that incorporate an integrated shutter for a period of twelve (12) months. This warranty applies to the standard shutter installed in the camera system at the time of manufacture. Non-standard shutters, SPR (special product request) shutters, and third-party shutter drive equipment carry no warranty expressed or implied. Photometrics will supply, at no cost to the customer, up to one (1) replacement shutter during the warranty period. Photometrics will, at Photometrics option, either ship a ready-to-install shutter to the customer site for installation by the customer according to the instructions in the product User Manual or arrange with the customer to return the camera system (or portion of the camera system) to the factory (or factory authorized service center) for shutter replacement by a factory-authorized agent. Responsibility for transportation and insurance charges is described above.

### Vacuum Integrity Limited 24 Month Warranty

Photometrics warrants the vacuum integrity of all our products for a period of up to twenty-four (24) months from the date of shipment. We warrant that the detector head will maintain the factory-set operating temperature without the requirement for customer pumping. Should the detector experience a Vacuum Integrity failure at anytime within twenty-four (24) months from the date of delivery all parts and labor needed to restore the vacuum integrity will be covered by us. Responsibility for shipping charges is as described above under our Basic Limited One (1) Year Warranty.

### X-Ray Detector Limited One Year Warranty

Photometrics warrants, with the exception of CCD imaging device and fiber optic assembly damage due to X-rays (which carry NO WARRANTIES EXPRESSED OR IMPLIED), all X-ray products for one (1) year after shipment. *See additional Basic Limited One (1) year Warranty terms and conditions above, which apply to this warranty.* Responsibility for shipping charges is as described above under our Basic Limited One (1) Year Warranty.

## **Software Limited Warranty**

Photometrics warrants all of our manufactured software discs to be free from substantial defects in materials and / or workmanship under normal use for a period of one (1) year from shipment. Photometrics does not warrant that the function of the software will meet your requirements or that operation will be uninterrupted or error free. You assume responsibility for selecting the software to achieve your intended results and for the use and results obtained from the software. In addition, during the one (1) year limited warranty, the original purchaser is entitled to receive free version upgrades. Version upgrades supplied free of charge will be in the form of a download from the Internet. Those customers who do not have access to the Internet may obtain the version upgrades on a CD-ROM from our factory for an incidental shipping and handling charge. *See Item 12 in the following section of this warranty ("Your Responsibility") for more information.*

## **Owner's Manual and Troubleshooting**

You should read the owner's manual thoroughly before operating this product. In the unlikely event that you should encounter difficulty operating this product, the owner's manual should be consulted before contacting the Photometrics technical support staff or authorized service representative for assistance. If you have consulted the owner's manual and the problem still persists, please contact the Photometrics technical support staff or our authorized service representative. *See Item 12 in the following section of this warranty ("Your Responsibility") for more information.*

## **Your Responsibility**

The above Limited Warranties are subject to the following terms and conditions:

1. You must retain your bill of sale (invoice) and present it upon request for service and repairs or provide other proof of purchase satisfactory to Photometrics.
2. You must notify the Photometrics factory service center within (30) days after you have taken delivery of a product or part that you believe to be defective. With the exception of customers who claim a "technical issue" with the operation of the product or part, all invoices must be paid in full in accordance with the terms of sale. Failure to pay invoices when due may result in the interruption and/or cancellation of your one (1) year limited warranty and/or any other warranty, expressed or implied.
3. All warranty service must be made by the Photometrics factory or, at our option, an authorized service center.
4. Before products or parts can be returned for service you must contact the Photometrics factory and receive a return authorization number (RMA). Products or parts returned for service without a return authorization evidenced by an RMA will be sent back freight collect.
5. These warranties are effective only if purchased from the Photometrics factory or one of our authorized manufacturer's representatives or distributors.
6. Unless specified in the original purchase agreement, Photometrics is not responsible for installation, setup, or disassembly at the customer's location.
7. Warranties extend only to defects in materials or workmanship as limited above and do not extend to any product or part which has:
  - been lost or discarded by you;
  - been damaged as a result of misuse, improper installation, faulty or inadequate maintenance or failure to follow instructions furnished by us;
  - had serial numbers removed, altered, defaced, or rendered illegible;
  - been subjected to improper or unauthorized repair; or
  - been damaged due to fire, flood, radiation, or other "acts of God" or other contingencies beyond the control of Photometrics.

8. After the warranty period has expired, you may contact the Photometrics factory or a Photometrics-authorized representative for repair information and/or extended warranty plans.
9. Physically damaged units or units that have been modified are not acceptable for repair in or out of warranty and will be returned as received.
10. All warranties implied by state law or non-U.S. laws, including the implied warranties of merchantability and fitness for a particular purpose, are expressly limited to the duration of the limited warranties set forth above. With the exception of any warranties implied by state law or non-U.S. laws, as hereby limited, the forgoing warranty is exclusive and in lieu of all other warranties, guarantees, agreements, and similar obligations of manufacturer or seller with respect to the repair or replacement of any parts. In no event shall Photometrics' liability exceed the cost of the repair or replacement of the defective product or part.
11. This limited warranty gives you specific legal rights and you may also have other rights that may vary from state to state and from country to country. Some states and countries do not allow limitations on how long an implied warranty lasts, when an action may be brought, or the exclusion or limitation of incidental or consequential damages, so the above provisions may not apply to you.
12. When contacting us for technical support or service assistance, please refer to the Photometrics factory of purchase, contact your authorized Photometrics representative or reseller, or visit our technical support page at [www.photomet.com](http://www.photomet.com).

## **Optional CoolSNAP Camera System Service Contract**

The optional CoolSNAP Camera System Service Contract provides extended coverage for the CoolSNAP camera system. All terms and conditions listed in the CoolSNAP Camera System Warranty, including those pertaining to shipping costs and appropriate system use, apply to the CoolSNAP Camera System Service Contract.

The Service Contract also guarantees that Photometrics shall ship a complete replacement CoolSNAP camera system within forty-eight (48) hours of receiving notification of a CoolSNAP camera system defect. All components of the defective CoolSNAP camera system must be returned to Photometrics. Shipment of these components should not be made without prior authorization by Photometrics.

When purchased within two (2) months of the date listed on the packing slip shipped with the original equipment, the Service Contract is valid for a period of twenty-seven (27) months from the packing slip date.

This period comprises the initial CoolSNAP Camera System Warranty period of twelve (12) months, the CoolSNAP Camera System Service Contract period of twelve (12) months, and an additional three (3) months of free coverage.

When purchased prior to the lapse of the CoolSNAP Camera System Warranty or an active CoolSNAP Camera System Service Contract, the CoolSNAP Camera System Service Contract is valid for twelve (12) months beyond the lapse date of the Camera System Warranty or current Service Contract.

The CoolSNAP Camera System Service Contract can be renewed repeatedly. If the renewal occurs outside of a period covered by Warranty or Service Contract, Photometrics may, at its sole discretion, require an inspection of the camera system as a condition of consent to place it under Service Contract.

## **U. S. Government Restricted Rights**

The software and documentation are provided with Restricted Rights. Use, duplication, or disclosure by the Government is subject to restrictions as set forth in subparagraph (c)(1)(ii) of the Rights in Technical Data and Computer Software clause at DFARS 252.227-7013 or subparagraphs (c)(1) and (2) of the Commercial Computer Software-Restricted Rights at 48 CFR 52.227-19, as applicable. Contractor/manufacturer is Photometrics, 3440 East Britannia Drive, Tucson, AZ 85706.

This license is effective until terminated. It will terminate upon the conditions set forth above or if you fail to comply with any term hereof. Upon termination, you agree that the software and accompanying materials, and all copies thereof, will be destroyed. This agreement is governed by the laws of the State of Arizona. You acknowledge that you have read this agreement, you understand it, you agree to be bound by its terms, and that this is the complete and exclusive statement of the agreement between you and Photometrics regarding the software.



# Declaration of Conformity

Roper Scientific, Inc. declares that the equipment described in this document is a CLASS A DEVICE in conformance with the requirements of the European Council Directives, listed below:

89/336/EEC	EMC Directive & Amendments
93/68/EEC	EMC Directive & Amendments
73/23/EEC	Product Safety with Amendments

on the application of the laws of Member States relating to Electromagnetic Compatibility and Product Safety.

This declaration is based upon compliance of the product to the following standards:

EN 55022	RF Emissions Control
EN 61000-3 Series	Harmonics & Flicker
EN 55024	Immunity from Electromagnetic Disturbances
EN 60950	Product Safety

Product Description: Video Camera  
Model: CoolSNAP<sub>cf</sub> / CoolSNAP<sub>ES</sub>  
Test Reports: EMC Rpt 2K01-0122-003B- EN55022  
EMC Rpt 2K00-0122-003C- EN55024  
EMC Rpt 2K01-0122-003D-EN61000-3 Series  
SAFETY Rpt 2K01-0122-003E-EN60950

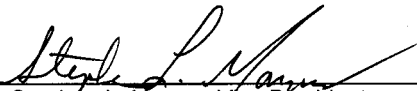
Authorized Signature:   
Stephen L. Marcus, Vice President

Roper Scientific, Inc.  
3440 East Britannica Drive  
Tucson, AZ, 85706  
USA



Manufacturer: ROPER SCIENTIFIC

# Declaration of Conformity

Roper Scientific, Inc. declares that the equipment described in this document is a CLASS A DEVICE in conformance with the requirements of the European Council Directives, listed below:

89/336/EEC	EMC Directive
92/31/EEC	Amendment
93/68/EEC	Amendment
73/23/EEC	Product Safety

on the application of the laws of Member States relating to Electromagnetic Compatibility and Product Safety.

This declaration is based upon compliance of the product to the following standards:

EN50082-1, EN60000-3-2	Current Harmonics
EN50082-1, EN60000-3-3	Voltage Fluctuations and Flicker
EN50082-1, EN61000-4-2	Electrostatic Discharge (ESD)
EN50082-1, EN61000-4-3	Radiated Electromagnetic Field (EMF)
EN50082-1, EN61000-4-4	Electrical Fast Transient/Burst (EFT)
EN50082-1, EN61000-4-5	Surge Immunity (Mains)
EN50082-1, EN61000-4-6	RF Injected Current
EN50082-1, EN61000-4-11	Voltage Dips and Interruptions
EN55022-1998	with Amendment A1:2000 (CISPR-22)

Product Description:	Video Camera
Model:	CoolSNAP <sub>cf</sub> / CoolSNAP <sub>ES</sub> , IEEE-1394

Authorized Signature:



E. J. Pisa, Vice President

Roper Scientific, Inc.  
3440 East Britannica Drive  
Tucson, AZ 85706  
USA

Manufacturer:	ROPER SCIENTIFIC
---------------	------------------



# Table of Contents

## Chapter 1. Introduction

Description.....	1
System Components.....	1
About This Manual.....	2
Precautions.....	2
Environmental Requirements.....	2
Storage Requirements.....	3
Microscopes, Lenses, and Tripods.....	3
Repairs.....	3
Cleaning.....	3
Photometrics Customer Service.....	4

## Chapter 2. System Installation

Introduction.....	5
Software Compatibility Requirements.....	5
Host Computer Requirements.....	5
Multiple Cameras.....	6
Software Installation.....	6
Installing the Interface Card.....	6
Connecting Your CoolSNAP Camera.....	7

## Chapter 3. Operating Features

Common Features.....	9
Readout Speed.....	9
Binning.....	9
CoolSNAP <sub>ES</sub> Features.....	9
Dual Mode Operation.....	9
Antiblooming.....	10
Application Examples.....	11

## Chapter 4. Troubleshooting

System Does Not Boot Normally.....	12
New Hardware Found Dialog Box Does Not Appear (Windows 2000/XP).....	12
Green LED Does Not Illuminate (Camera Has No Power).....	12
Images Not Displayed Properly.....	13
Bright Spots in Image / Increased Background Noise.....	13
Camera Running Too Warm.....	13
PVCAM Error Message Appears.....	13
Lengthy Pauses During Imaging.....	13
IEEE-1394 CoolSNAP Camera will Not Image When Attached to Certain Dual-processor or Hyperthreading-capable PCs.....	14

## **Chapter 5. Basic Specifications**

Dimensions .....	15
CCD Specifications and Orientations.....	17
Additional Measurements .....	17
Detector .....	18
Auxiliary Power Supply.....	19
Usage Requirements.....	19
Installation .....	19
Specifications .....	19
<b>Index.....</b>	<b>20</b>

# Chapter 1. Introduction

## Description

CoolSNAP<sub>cf</sub> and CoolSNAP<sub>ES</sub>, from Photometrics®, are ideal cameras for digital microscopy and many other biological applications. The simple, compact CoolSNAP<sub>cf</sub> incorporates a high-quality CCD (charge-coupled device), a 12-bit scientific digitizer, and low-noise electronics to produce high-quality 12-bit monochrome or 36-bit digital color images at greater than 1k x 1k resolution. The CoolSNAP<sub>ES</sub> offers higher sensitivity (especially in the red region) and lower read noise to produce high quality 12-bit monochrome images.

---

**Note:** Unless otherwise noted, the CoolSNAP<sub>cf</sub> and the CoolSNAP<sub>ES</sub> cameras are referred to by the name "CoolSNAP".

---

## System Components

Components for the CoolSNAP™ camera system are listed as follows:

- Camera
- Interface hardware (high-speed digital LVDS or IEEE-1394 data-transfer interface card)
- Data cable (connects camera and interface hardware)
- Software discs (PVCAM® drivers included)



**CoolSNAP Camera with Test Lens**



**CoolSNAP IEEE-1394 Cable**



**CoolSNAP LVDS Cable**



**CoolSNAP IEEE-1394 Interface Card**



**CoolSNAP LVDS Interface Card**

## About This Manual

The *CoolSNAP User Manual* is divided into five chapters. It is suggested that you read the entire manual before operating the camera in order to ensure proper use. The chapters that follow this introduction are:

- **System Installation** — Instructions for installing the camera system's hardware and software.
- **Operating Features** — Descriptions of specific camera features.
- **Troubleshooting** — Answers to camera system problems.
- **Basic Specifications** — Specifications for CoolSNAP components.

## Precautions

The CCD and other system electronics are extremely sensitive to electrostatic discharge (ESD). To avoid permanently damaging the system, please observe the following precautions:

- This is a Class A product. In a domestic environment, this product may cause radio interference, in which case, the user may be required to take adequate measures.
- If you are using high-voltage equipment (such as an arc lamp) with your camera system, be sure to turn the camera power *on last* and power the camera *off first*.
- Never connect or disconnect any cable while the camera system is powered on (LVDS cameras only).
- Although you should switch off the *camera's* power before disconnecting the CoolSNAP cable from the DATA connector or the PCI card, you do *not* need to power off your computer to detach the cable.
- Use caution when triggering high-current switching devices (such as an arc lamp) near your system. The CCD can be permanently damaged by transient voltage spikes. If electrically noisy devices are present, an isolated, conditioned power line or dedicated isolation transformer is highly recommended.
- Always leave 1/2 inch of space around the camera's external cooling fins for air flow.
- Never open the camera. There are no user-serviceable parts inside the CoolSNAP camera. Opening the camera voids the warranty.
- Use only a CoolSNAP data cable and a CoolSNAP interface card with your CoolSNAP camera. Using a different cable or interface card may result in permanent damage to your system.
- Do not use a screw longer than 1/4 inch (6.3 mm) in the camera's tripod mounting hole.
- Do not use a C-mount lens having optics that extend farther than .47 inches (11.9 mm) behind the flange of the lens.

## Environmental Requirements

The CoolSNAP camera system should be operated in a clean, non-condensing environment.

The camera system's ambient operating temperature is 15°C to 30°C.

## **Storage Requirements**

Store the CoolSNAP camera system in its original containers. To protect the system from excessive heat, cold, and moisture, store at an ambient temperature between 0°C and 70°C with a relative humidity of 0%-80% noncondensing.

## **Microscopes, Lenses, and Tripods**

The camera has a standard threaded video mount and can be mounted to any microscope that accepts a standard C-mount adapter. The camera also allows you to install any lens that is compatible with a standard threaded video mount as long as its optics do not extend farther than .47 inches (11.9 mm) behind the flange of the lens. The CoolSNAP camera can be mounted to a tripod using the tripod-mounting hole located on the bottom of the camera. See *Additional Measurements* on page 17 for more information.

---

**Note: In microscopy applications, a 0.5x C-mount camera coupler is recommended for an expanded field of view.**

---

## **Repairs**

The CoolSNAP camera system contains no user-serviceable parts. Repairs must be done by Photometrics. Should your camera system need repair, contact Photometrics Customer Service. Please save the original packing materials so you can safely ship the camera system to another location or return it for repairs if necessary.

---

**Note: Do not open the camera. Opening the CoolSNAP camera voids the warranty.**

---

## **Cleaning**

Clean exterior surfaces of the camera with a dry, lint-free cloth. To remove stains, contact Photometrics Customer Service.

To clean the camera's imaging window, use only a filtered compressed-air source. Do not touch the window.

## Photometrics Customer Service

If you have any questions about your camera system, contact Photometrics Customer Service. When you call, please have your Photometrics sales order number or equipment serial numbers available.

- Tel: 800. 874.9789/520.889.9933 between 8:00 am and 5:00 pm MST
- Fax: 520.295.0299
- Email: [cservice@photomet.com](mailto:cservice@photomet.com)
- Mail: Photometrics  
3440 East Britannia Drive  
Tucson, Arizona 85706

In Europe, you can reach Customer Service at:

### BENELUX

- Tel: 31.347.324989
- Fax: 31.347.324979
- Email: [mailto@roperscientific.com](mailto:mailto@roperscientific.com)
- Mail: Roper Scientific, BV  
Ir. D.S. Tuijnmanweg 10  
4131 PN VIANEN, Netherlands

### FRANCE

- Tel: 33.160.86.03.65
- Fax: 33.160.86.07.09
- Email: [princeton.instruments@wanadoo.fr](mailto:princeton.instruments@wanadoo.fr)
- Mail: Roper Scientific, SARL  
Z.I. Petite Montagne Sud  
4, rue de l'Oisans - C.E. 1702  
91017 Evry Cedex, France

### GERMANY

- Tel: 49.89.660.779.3
- Fax: 49.89.660.779.50
- Email: [mail@roperscientific.de](mailto:mail@roperscientific.de)
- Mail: Roper Scientific, GmbH  
Rosenheimer Landstr. 87  
D-85521 Ottobrunn, Germany

In Japan, you can reach Customer Service at:

- Tel: 81.3.5639.2731
- Fax: 81.3.5639.2775
- Email: [sales@roper.co.jp](mailto:sales@roper.co.jp)
- Mail: Nippon Roper, K.K.  
Sakurai Building  
2-8-19 Fukagawa  
Koto-ku, Tokyo  
Japan 135-0033

General product information and answers to some customer service questions can be found on our website: <http://www.photomet.com>



# System Installation

---

Carefully review the *Precautions* section on page 2 before performing any of the procedures outlined here. Again, use only a CoolSNAP cable and a CoolSNAP interface card with your CoolSNAP camera. Using a different cable or interface card may result in permanent damage to your system.

---

## Introduction

Your CoolSNAP<sub>cf</sub> or CoolSNAP<sub>ES</sub> camera system has the following hardware components:

- Camera
- Data cable
- Interface card

CoolSNAP system components are linked by the data cable and controlled by your host computer system. All of these hardware components should be included with your shipment. Refer to the information and figures in *System Components* on page 1.

The CCD you selected is installed in your camera.

Keep all the original packing materials so you can safely ship the CoolSNAP system to another location or return it for service if necessary.

If you have any difficulty with any step of the instructions, call Photometrics Customer Service.

## Software Compatibility Requirements

The CoolSNAP package includes an image-capture software program designed for use with your CoolSNAP camera.

All other imaging software must also be PVCAM-compatible. For full access to imaging software functions, the most current version of PVCAM must be used.

## Host Computer Requirements

The host computer (PC) for your CoolSNAP camera must have the following:

- Windows® 2000 or XP operating system
- 1 GHz Pentium® 4 (or greater)
- 256 MB RAM (or greater)
- CD-ROM drive
- At least one unused PCI or PCI-X card slot
- 16-bit color display (or greater)

If you are a Mac user, the host computer for your CoolSNAP camera must have the following:

- Macintosh OS X.3 (Panther) operating system
- 512 MB RAM (or greater)
- CD-ROM drive
- At least one unused PCI or PCI-X card slot (LVDS cameras only)
- At least one unused IEEE-1394 port (IEEE-1394 cameras only)
- Video adapter that supports 24-bit color (millions of colors)

## Multiple Cameras

Windows versions of PVCAM support multiple open LVDS cameras. In order to use this function, it must also be supported by your imaging software. Many imaging packages support multiple open cameras.

If your imaging software supports multiple cameras, there must be a separate PCI card for each camera.

PVCAM for Macintosh, PVCAM for Linux, and IEEE-1394 cameras do not support the multiple open camera feature.

## Software Installation

An Installation Guide appropriate to your system is included with your camera system. This guide provides step-by-step instructions for installing the camera interface software and the application software for Windows-based and Macintosh-based PCs. Additional instructions are included for installing a PCI card in your computer and capturing images.

The Photometrics CD-ROM contains the following files.

- **Linux directory** — this directory contains the files for installing on a Linux PC.
- **MacOS directory** — this directory contains the files required for installing on a Macintosh computer.
- **Manuals directory** — this directory contains user manuals in PDF format.
- **WinOS directory** — this directory contains the files for installing on a Windows PC.

## Installing the Interface Card

You will be using a CoolSNAP interface card to allow the camera to communicate with your computer.

Refer to the Readme text files on the CD-ROM and to the Software Installation insert before installing the interface card.

After installing the interface card, proceed to *Connecting your CoolSNAP Camera* on page 7.

## Connecting Your CoolSNAP Camera

The CoolSNAP cable connects your CoolSNAP camera to the interface card. This cable is designed to serve as a conduit both for data and power.



**CoolSNAP IEEE-1394 Cable**



**CoolSNAP LVDS Cable**

### To connect your LVDS CoolSNAP camera:

1. Connect either end of the CoolSNAP LVDS cable to the CoolSNAP interface card that you have installed in the host computer.
2. Connect the other end of the CoolSNAP LVDS cable to the DATA connector located on the back of the camera (shown below).



The following connectors and display lights, as well as the power switch, are located on the back of the CoolSNAP camera.

- **DATA connector:** 20-pin, high-density connector for data transfer and power.
- **EXPOSE OUT connector:** BNC connector; the signal at the BNC connector will go to a TTL high level when the exposure begins; useful for synchronizing an external shutter in the illumination pathway; will not power the shutter.
- **XFER display light:** amber LED illuminates during data transfer.
- **ON display light:** green LED illuminates when camera is powered on.
- **POWER switch:** momentary on/off rocker switch (CoolSNAP<sub>cf</sub>) or standard rocker switch (CoolSNAP<sub>ES</sub>).

---

**Note:** LVDS CoolSNAP cameras draw power from the PCI bus via the PCI card. Therefore, the computer must be powered on for the LVDS CoolSNAP camera to operate.

---

**To connect your IEEE-1394 CoolSNAP camera:**

1. Connect either end of the CoolSNAP IEEE-1394 cable to the CoolSNAP IEEE-1394 interface card that you have installed in the host computer.
2. Connect the other end of the CoolSNAP IEEE-1394 interface cable to either DATA connector located on the back of the camera (shown below).



The following connectors and display lights are located on the back of the CoolSNAP camera.

- **DATA connectors:** 6-pin IEEE-1394 connectors for data transfer and power.
- **EXPOSE OUT connector:** BNC connector; the signal at the BNC connector will go to a TTL high level when the exposure begins; useful for synchronizing an external shutter in the illumination pathway; will not power the shutter.
- **XFER display light:** amber LED illuminates during data transfer.
- **PWR display light:** green LED illuminates when camera is powered on.
- **EXT PWR connector:** 5.5 x 2.1 mm DC jack for auxiliary CoolSNAP power supply.

---

**Note:** IEEE-1394 CoolSNAP cameras draw power from the IEEE-1394 bus. Therefore, the computer must be powered on for the IEEE-1394 CoolSNAP camera to operate.

---

# Operating Features

## Common Features

The features described in this section are identical in the CoolSNAP<sub>cf</sub> and CoolSNAP<sub>ES</sub> cameras. Features that are specific to the CoolSNAP<sub>ES</sub> camera are described separately in the "CoolSNAP<sub>ES</sub>" section.

### Readout Speed

The CoolSNAP<sub>cf</sub> and CoolSNAP<sub>ES</sub> cameras operate at 20 MHz digitization and offer greater than 10 full frames per second.

### Binning

Both cameras support 1x, 2x, 3x, 4x, and 8x binning in the serial (horizontal) direction and flexible binning in the parallel (vertical) direction. Binning increases the frame rate and sensitivity but at the expense of resolution. Choosing a smaller region of interest (ROI) further increases the frame rate.

## CoolSNAP<sub>ES</sub> Features

The following subsections describe features that are specific to CoolSNAP<sub>ES</sub> camera systems.

### Dual Mode Operation

A unique feature of CoolSNAP<sub>ES</sub> is that it allows two different CCD clocking modes that allow you choose between speed and NIR sensitivity. In the PVCAM implementation, the clocking modes are referred to as "normal" and "alternate normal".

#### Normal mode

In "Normal" mode, the CCD is optimized for maximum anti-blooming protection and frame rate. In this mode, the CCD can be clocked so that exposure and readout happen simultaneously as shown in the example below.

**Example:** Consider a situation where the full frame readout time is 90 msec (at 20 MHz) and the exposure time is 200 msec. The readout of a frame will occur during the exposure of the next frame. This is possible because the CCD has alternate columns of sensitive and masked areas. While charge is integrating in the sensor area, the previous frame, which is in the masked area, can be read out (Figure 1). In this example, the time required to acquire the three-image sequence is 690 ms (3 x 200 + 90) and the frame rate is approximately 4.3 fps.

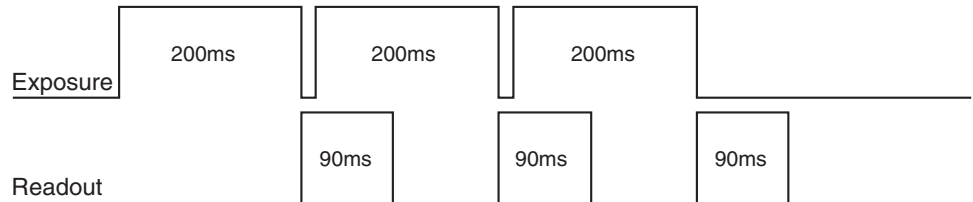
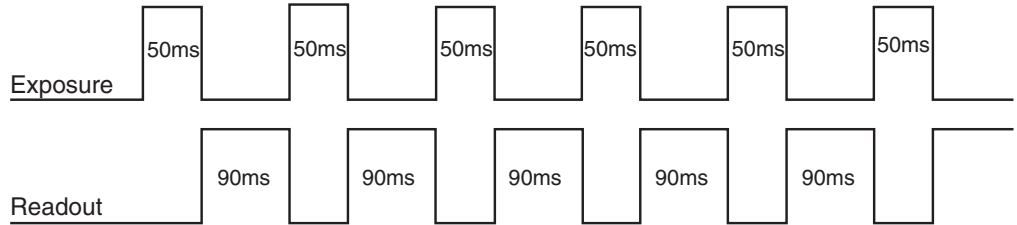

Figure 1. Normal Mode, Overlapped

If the exposure time is 50 ms, which is less than the readout time, the camera operates in "nonoverlapped" mode (see Figure 2). The effective frame rate for this is 7.14 fps ( $1/[0.05+0.090]$ ). While in normal mode, the camera firmware automatically calculates the readout times, taking into account binning and/or subregion, and carries out the exposure-readout sequence to maximize the frame rate.



**Figure 2. Normal Mode, Nonoverlapped**

**Alternate Normal mode**

In "Alt-Normal", it is possible to achieve higher QE in the NIR (peak QE of approximately 65%) by manipulating the CCD clock voltages. Also, in this high-sensitivity mode, the preamplifier is switched off during the exposure to eliminate the background generated by preamplifier glow. In this clocking mode, irrespective of what the exposure time is, the camera operates in "nonoverlapped" or "sequential" mode.

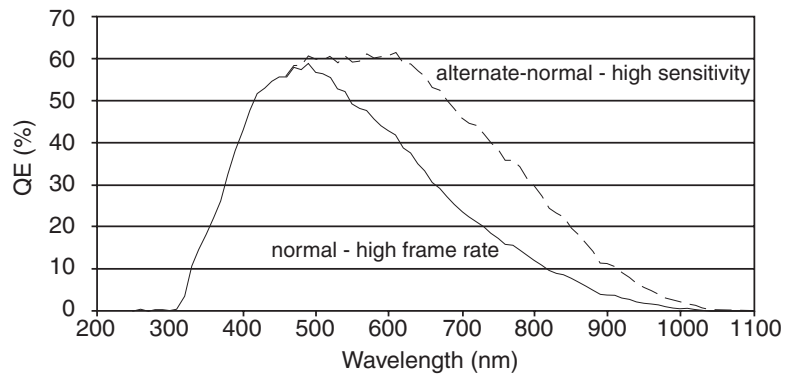

**Figure 3. QE for Normal and Alternate Normal Modes**

**Antiblooming**

Typically, interline CCD devices are designed with antiblooming capabilities. To prevent excess electronic charge from migrating to adjacent pixels, "drains" are built into the CCD. These drains remove any excessive charge generated from an overexposed pixel. Sony interline CCDs will prevent blooming for optical signals greater than 1000 times the full-well capacity of a single pixel. However, the extended QE capabilities of the Sony ICX285 in the CoolSNAP<sub>ES</sub> reduce the antiblooming suppression for certain modes. In normal mode, the CCD operates with typical antiblooming suppression. But in alternate normal mode, the enhanced sensitivity causes a reduction in antiblooming to greater than 100 times single-pixel full-well capacity.

## Application Examples

Example 1 "I have a CoolSNAP<sub>ES</sub> and want to operate the camera in the most sensitive setting for taking high-resolution, single images."

For this application, the camera should be operated in "alternate normal" mode to provide the best quantum efficiency and the camera gain should be set to 2. These settings will operate the camera in its most sensitive mode.

Example 2 "I would like to acquire sequences of images with a CoolSNAP<sub>ES</sub> to study time-correlated phenomena. My light level is fairly high and I want to optimize the acquisition rate of the camera."

First, the camera speed should be set to 20 MHz. In addition, the camera should be put into "normal" mode to take advantage of the overlapping of the readout with the integration time. Finally, the "clearing" mode of the camera should be set to "clear pre-sequence" to remove the clearing overhead between frames. Of course, reducing the region of interest and increasing binning will always increase the frame rate further.

# Troubleshooting

*If you have any difficulty while troubleshooting, or do not see your camera system's symptoms listed here, contact Photometrics Customer Service.*

## System Does Not Boot Normally

If your operating system does not boot normally after you have installed a interface card, try installing the new card in another open interface slot. If this does not work:

1. Turn off your computer and remove the newly installed interface card.
2. Turn your computer back on. If your system boots normally, there is probably an interrupt conflict between a previously installed expansion card and the interface card that you are installing.
3. If you need assistance resolving the interrupt conflict, contact Photometrics Customer Service.

## New Hardware Found Dialog Box Does Not Appear (Windows 2000/XP)

If the New Hardware Found dialog box does not appear after installing a new interface card to your computer and booting Windows 2000/XP:

- Check to make sure that the new interface card is inserted in a PCI slot according to your computer manufacturer's instructions and that the Photometrics disc is in the host computer's CD drive.
- It is possible that there is a conflict between the new interface card and a previously installed expansion card. *With the computer's power turned off*, remove any previously installed expansion cards that your system does not need to function. (If you are unsure which cards can be safely removed, call Photometrics Customer Service.) Then turn your computer back on and boot Windows 2000/XP again.
- If the New Hardware Found dialog box still does not appear, contact Photometrics Customer Service.

## Green LED Does Not Illuminate (Camera Has No Power)

If the green LED on the back of the camera does not illuminate when the power switch is pressed to the ON position:

Check to make sure that the host computer has power:

- If it does not, power the computer on and then switch on the camera.
- If it does, power off the computer, check all system connections (particularly both ends of the data cable), power the computer back on, and then switch on the camera again.
- If you are using a CoolSNAP camera with an IEEE-1394 interface, connect only one camera at a time to the IEEE-1394 interface card.
- If the camera still does not have power, contact Photometrics Customer Service.



## **Images Not Displayed Properly**

If the amber LED on the back of the camera does not illuminate while images are being acquired and no images appear:

- Confirm that the green LED on the back of the camera is illuminated, indicating that the camera is powered on. See *Green LED Does Not Illuminate (Camera Has No Power)* on page 12.
- Confirm that the correct CoolSNAP camera is selected in your imaging software application.
- Power off the camera and the host computer and check all system connections (particularly both ends of the data cable). Restart. If the amber LED on the back of the camera does illuminate while images are being taken, but no images appear:
  - Confirm that Windows is set for at least 16-bit colors.
  - Confirm that the camera is operational by taking an image with a standard C-mount lens attached to your CoolSNAP. Using normal room lighting, place the camera on a table about 3 meters away from an object and acquire an image using your system's Brightfield settings.

If the problem persists, contact Photometrics Customer Service.

## **Bright Spots in Image / Increased Background Noise Camera Running Too Warm**

If you notice bright spots (hot pixels) in the image or an increase in background noise, take another calibration image and then re-acquire the original image.

It is normal for the camera to be slightly warm to the touch while in operation. However, if the camera is more than slightly warm to the touch (and at least 1/2 inch of space has been left around the external cooling fins for air flow), switch off the camera immediately and contact Photometrics Customer Service.

## **PVCAM Error Message Appears**

If a PVCAM error message appears, note the message's number code and contact Photometrics Customer Service.

## **Lengthy Pauses During Imaging**

If you notice lengthy pauses marked by a lot of disk activity while imaging:

- Close any other programs that may be running.
- Install more physical memory to your computer system.

**IEEE-1394  
CoolSNAP  
Camera will Not  
Image When  
Attached to  
Certain Dual-  
processor or  
Hyperthreading-  
capable PCs**

Some high-end Windows 2000/XP-enabled computers with Intel Pentium or Xeon™ processors include a memory enhancement called Physical Address Extension (PAE). PAE allows these computers to address memory above 4GB; however, when PAE is enabled the IEEE-1394 CoolSNAP camera will not transmit any pixel data.

To determine whether your computer is running with PAE enabled, go to the Control Panel and open the "System" icon. Under the "General" tab, you will find a reference to Physical Address Extension in the "Computer" section.

To disable PAE, you must edit your C:\boot.ini file and remove the /PAE flag.

# Basic Specifications

## Dimensions

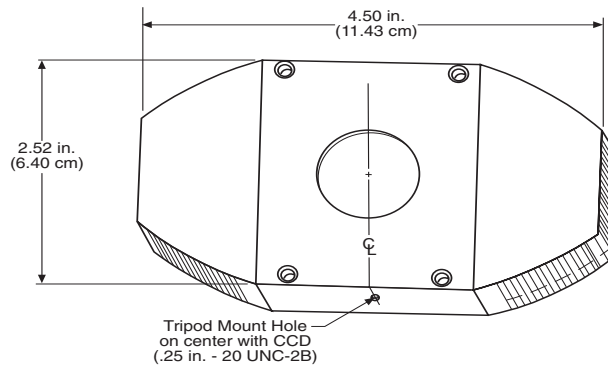

**CoolSNAP Camera: Front View**

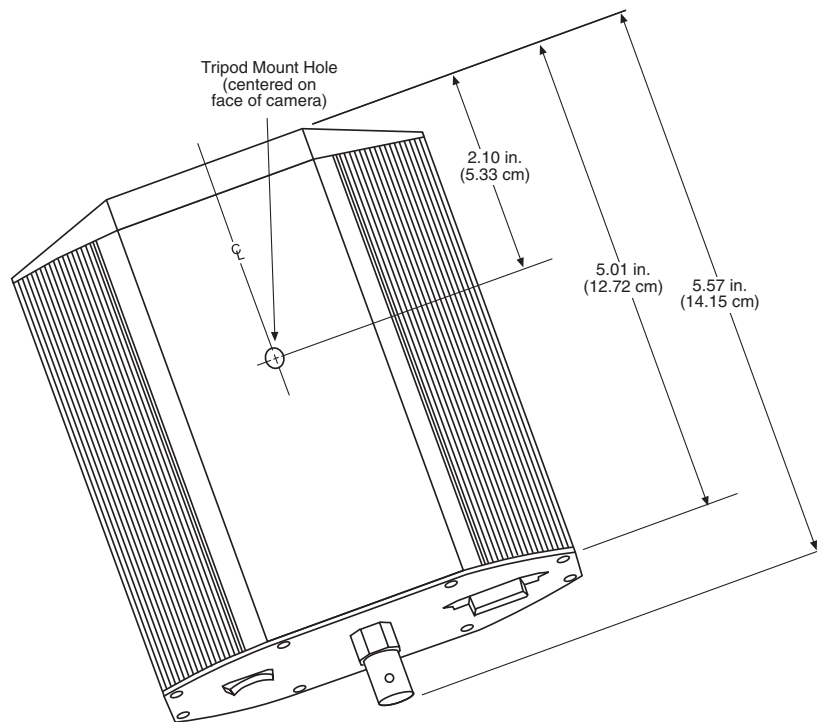

**CoolSNAP LVDS Camera: Side View**

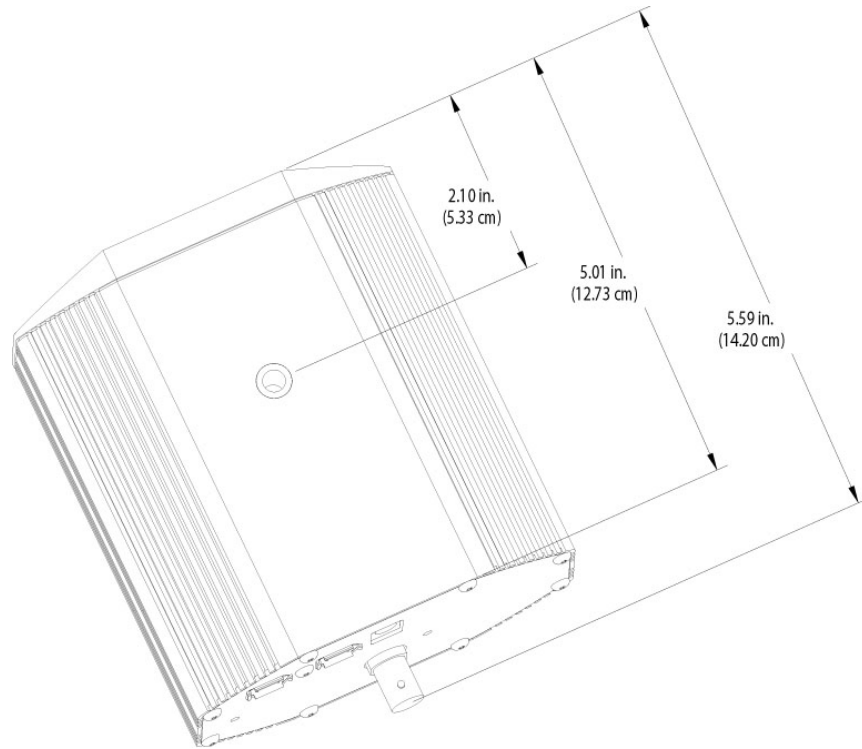

**CoolSNAP IEEE-1394 Camera: Side View**

# CCD Specifications and Orientations

	<i>CoolSNAP<sub>ef</sub></i>	<i>CoolSNAP<sub>ES</sub></i>
<i>Image Type</i>	Color and Mono	Mono
<i>Array</i>	Sony ICX205AK (color) Sony ICX205AL (mono)	Sony ICX285AL
<i>Resolution</i>	1392 x 1040	1392 x 1040
<i>Pixel Size</i>	4.65 μm x 4.65 μm	6.45 μm x 6.45 μm
<i>Digitization Rate</i>	20 MHz	20 MHz
<i>Readout Noise</i>	15 e- rms @ 20 MHz	8 e- rms at 20 MHz
<i>Cooling</i>	Thermoelectric, 5°C below ambient temperature	Thermoelectric, 5°C below ambient temperature

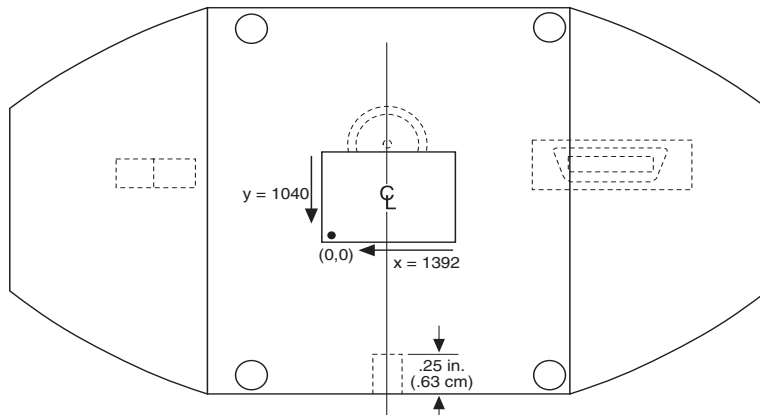

**CCD Orientation, LVDS Camera**

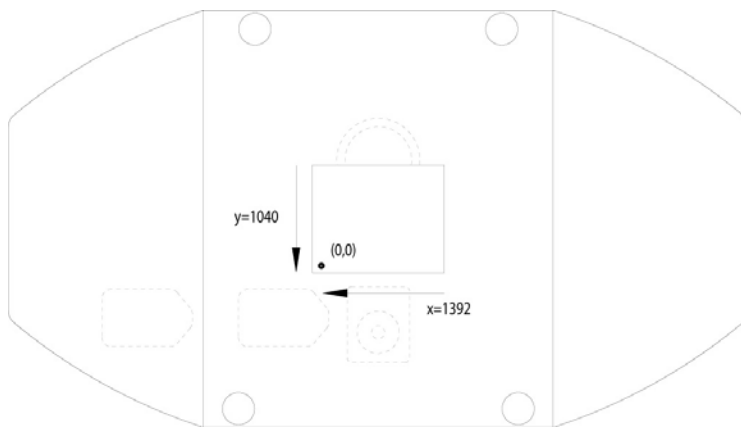

**CCD Orientation, IEEE-1394 Camera**

## Additional Measurements

- Camera weight:* 1.9 lb. (863 g)
- Tripod mounting hole (bottom of camera):* .25 in.-20 UNC-2B
- Safe tripod mounting screw length:* .25 in. (.63 cm)
- Safe C-mount depth:* .47 in. (11.9 mm)
- Flange focal distance:* .69 in. (17.5 mm)

## Detector

### Rear Panel Description

The following connectors, display lights, and controls are located on the back of the cameras (pictured below).

**DATA connector:** for data transfer and power

- LVDS cameras: 20-pin, high-density connector
- IEEE-1394 cameras: 6-pin IEEE-1394 connector

**EXPOSE OUT connector:** BNC connector; the signal at the BNC connector will go to a TTL high level (+ 5 V) when the exposure begins; useful for synchronizing an external shutter in the illumination pathway; will not power the shutter

**XFER display light:** amber LED illuminates during data transfer

**ON display light (LVDS camera)/PWR display light (IEEE-1394 cameras):** green LED illuminates when camera is powered on

**POWER switch (LVDS cameras only):** standard rocker switch

**EXT PWR connector (IEEE-1394 cameras only):** 5.5 x 2.1-mm DC jack for auxiliary CoolSNAP power supply



**CoolSNAP LVDS Rear Panel**



**CoolSNAP IEEE-1394 Rear Panel**

## Auxiliary Power Supply

### Usage Requirements

The auxiliary CoolSNAP power supply (shown below) provides power to your CoolSNAP camera, but is required only under certain conditions.

If your CoolSNAP camera is connected to an IEEE-1394 port that does not supply power (such as a 4-pin connector on a laptop computer) you need to use the auxiliary power supply.

The data ports on the CoolSNAP camera do not pass power. If the CoolSNAP camera is connected in a daisy chain configuration, and it is not the first device in the daisy chain, you need to use the auxiliary power supply.

If the CoolSNAP camera is connected to a PC that supplies power through the 6-pin IEEE-1394 port, the auxiliary power supply is not needed; however, connecting the power supply will not damage the camera.

---

**Warning: Use the auxiliary power supply that shipped with your system ONLY. Do not use third-party power supplies.**

---



### Installation

The auxiliary power supply ships with four unique wall plugs. You need to install one of the plugs on the power supply before using it. Select the correct plug for your wall socket and press it into the power supply. The supplied plugs include:

- NEMA 1-15 for North America/Japan
- BS1363/A for United Kingdom
- EN50075 for Europe
- AS/NZS 3112-1993 for Australia/New Zealand

### Specifications

Input voltage: 90-264 VAC/47-63 Hz

Output voltage: 12 VDC

Output current (maximum): 1250 mA

# Index

## A

Alternate normal mode · 10  
Antiblooming · 10  
Application examples · 11  
Auxiliary power supply · 19

## C

Camera cable  
    installation · 7  
Camera description · 1  
Camera features · 9  
CCP orientation · 17  
Cleaning  
    exterior camera surfaces · 3  
    imaging window · 3  
Clocking modes  
    alternate normal · 10  
    normal · 9  
Connecting  
    your CoolSNAP IEEE-1394 camera · 8  
    your CoolSNAP LVDS camera · 7  
Connectors and display lights · 7, 18  
Customer service · 4

## D

DATA connector · 7, 18  
Declaration of Conformity · v, vi  
Dimensions · 17  
Display lights and connectors · 7, 18

## E

Examples of applications · 11  
EXPOSE OUT connector · 18

## H

Hardware installation  
    camera cable · 7  
Host computer requirements · 5

## I

IEEE-1394 cable · 1  
IEEE-1394 interface card · 1

## L

Lenses · 3  
LVDS cable · 1  
LVDS interface card · 1

## M

Microscopes · 3

## Mount

    camera · 3  
Multiple cameras · 6

## N

Normal mode · 9

## O

ON display light · 7, 18  
Optional service contract · iv

## P

POWER switch · 7  
Precautions · 2

## R

Repairs · 3  
Restricted rights · iv

## S

Service Contract (optional) · iv  
Software compatibility requirements · 5  
Specifications · 17  
System components · 1

## T

Tripods · 3  
Troubleshooting · 12–13

## U

U.S. Government Restricted Rights · iv

## V

Video output · 11

## W

Warranties  
    normal wear item disclaimer · i  
    one year · i  
    one year on refurbished/discontinued products · i  
    owner's manual and troubleshooting · ii  
    software · ii  
    vacuum integrity · i  
    x-ray detector · i  
    your responsibility · ii  
Website · 4

## X

XFER display light · 7, 18



**BENELUX**

Roper Scientific, BV  
Ir. D.S. Tuijnmanweg 10  
4131 PN VIANEN, Netherlands  
tel: 31.347.324989  
fax: 31.347.324979  
email: [mailto@roperscientific.com](mailto:mailto@roperscientific.com)

**FRANCE**

Roper Scientific, SARL  
Z.I. Petite Montagne Sud  
4, rue de l'Oisans - C.E. 1702  
91017 Evry Cedex, France  
tel: 33.160.86.03.65  
fax: 33.160.86.07.09  
email: [princeton.instruments@wanadoo.fr](mailto:princeton.instruments@wanadoo.fr)

**GERMANY**

Roper Scientific, GmbH  
Rosenheimer Landstr. 87  
D-85521 Ottobrunn, Germany  
tel: 49.89.660.779.3  
fax: 49.89.660.779.50  
email: [mail@roperscientific.de](mailto:mail@roperscientific.de)

**JAPAN**

Nippon Roper, K.K.  
Sakurai Building,  
2-8-19 Fukugawa  
Koto-ku, Tokyo  
Japan 135-0033  
tel: 81.3.5639.2731  
fax: 81.3.5639.2775  
email: [sales@roper.co.jp](mailto:sales@roper.co.jp)

**USA**

Photometrics  
3440 East Britannia Drive  
Tucson, Arizona 85706  
tel: 800.874.9789 or 520.889.9933  
fax: 520.295.0299  
email: [cservice@photomet.com](mailto:cservice@photomet.com)